

**DPC-1**  
**Programmable digital thermostat**  
**with communication**  
**Versión 2.0**



Ref: Y-R70110 0306

**Technical Information**



Clima Roca York S.L. is participating in the EUROVENT Certification Program. Products are as listed in the EUROVENT Directory of Certified Products, in the program AC1, AC2, AC3, LCP and FC.



<b>Index</b>	<b>Page</b>	<b>Page</b>
<b>Internal view of the thermostat</b>	5	
<b>Description of the display</b>	5	
<b>Air conditioning modes</b>	6	
- Off	6	
- Cool	6	
- Heat	6	
- Auto	6	
- Programmed	6	
- Emergency heat	6	
- Vent only	7	
<b>Ventilation</b>	7	
<b>Operating modes</b>	7	
<b>Key functions</b>	8	
- Programming key	8	
- Plus and minus key	8	
- Air conditioning mode key	8	
- Occupation mode key	8	
- Fan mode key	9	
- Outdoor temperature key	9	
<b>Programming menu</b>	9	
- Clock setting	10	
- Programming the fan	10	
- Selection of time schedule profiles	10	
- Programming user profile	11	
- Programming comfort temperature set point (occupation or day)	11	
- Programming economy temperature set point (stand-by or night)	11	
		- Programming unoccupied temperature set points 12
		<b>Thermostat in unoccupied mode</b> 12
		<b>Menu of supervising program</b> 12
		- Programming calibrations of temperature readings 12
		- Programming origin of temperature readings 13
		- Programming operating mode of the temperature control 13
		- Activation and deactivation of communication error readout 13
		- Selection of outdoor probe type 14
		<b>Micro-switches for configuration of the thermostat</b> 14
		<b>Default parameters</b> 15
		<b>Alarms</b> 15
		- Table of failures 15
		<b>Temperature control</b> 15
		<b>Communication</b> 16
		<b>Installation instructions</b> 16
		- Location 16
		- Basic elements 16
		- Fastening the thermostat to the wall 16
		- Standard electric connections, thermostat DPC-1 17
		- Temperature table 18



## Internal view of the thermostat

1 - With the front cover down; normal position.

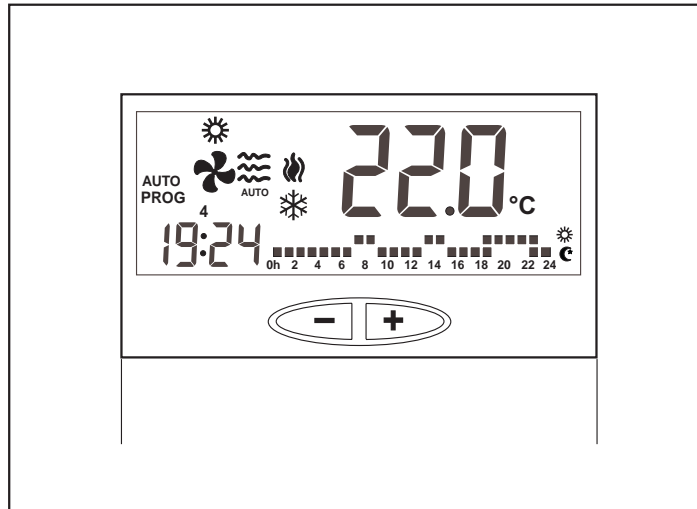

2 - With the front cover up, showing the front panel. Raise the cover to access the controls only.

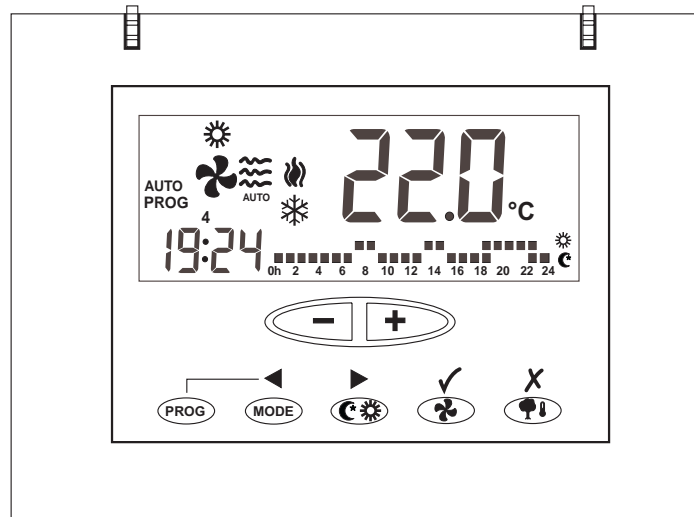

## Description of the display

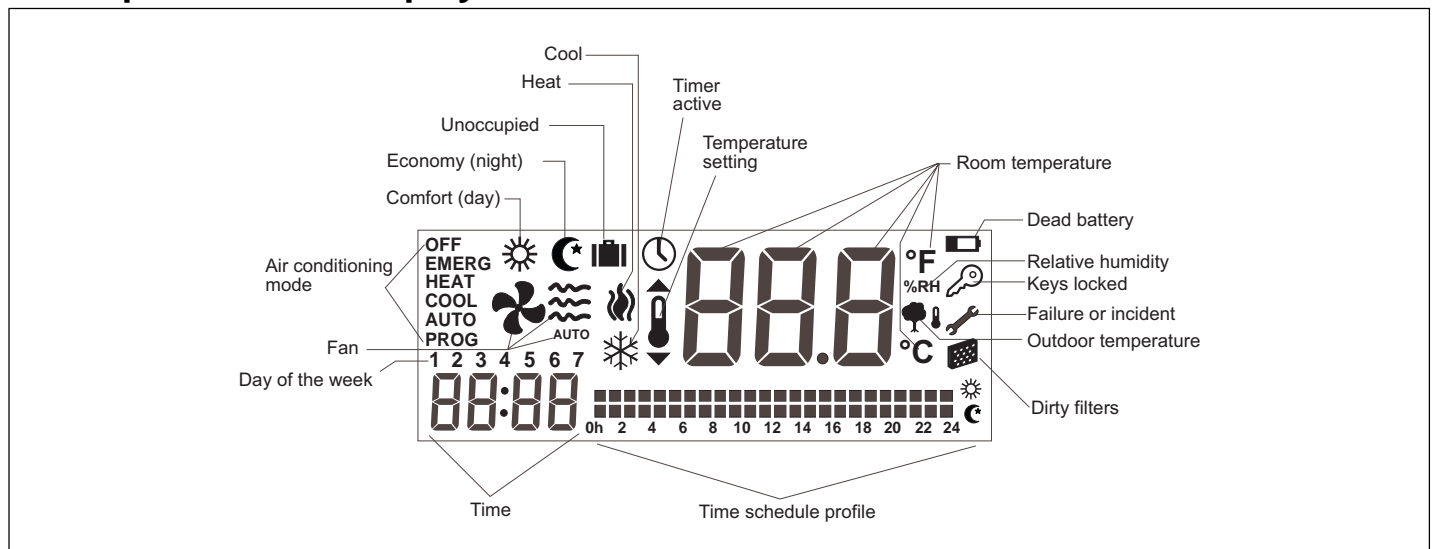

## Air conditioning modes

By pressing the **MODE** key consecutively, the following air conditioning modes can be selected.

### Off

In this mode the air conditioning system is off. The screen displays the word **OFF**, the room temperature, the day of the week and the time. If the fan is active, this will also be shown.



Entering this mode gives access to the configuration values that could have been changed temporarily, the set points and fan status.

### Cool

This mode activates cooling operation only. The screen displays the word **COOL** (air conditioning mode), room temperature, the ❄️ icon (flashing if there really is a demand, and static if not), room occupation status (Day, Night or Unoccupied), fan status, day of the week and time.



A demand is generated when the room temperature is above the programmed set point. Set point is understood as the temperature we want in the room. How to program and change set points will be described further below.

### Heat

This mode activates heating operation only. The screen displays the word **HEAT** (air conditioning mode), room temperature, the 🔥 icon (sides flashing if there really is a demand, and no sides if not), room occupation status (Day, Night or Unoccupied), fan status, day of the week and time.



A demand is generated when the room temperature is below the programmed set point. Set point is understood as the temperature we want in the room.

### Auto

This mode activates heating as well as cooling operations. The screen displays room temperature, the word **AUTO** (air conditioning mode), the 🔥 and ❄️ icons (flashing if there is a demand), room occupation status (Day, Night or Unoccupied), fan status, day of the week and time.



A demand is generated when the room temperature is above the cooling set point or below the heating set point. In automatic mode, room temperature is kept at a value between these two programmed set points.

## Programmed

The programmed mode involves the previously described **AUTO** mode and includes the time schedule profile. The **AUTO PROG** air conditioning mode appears on the display.

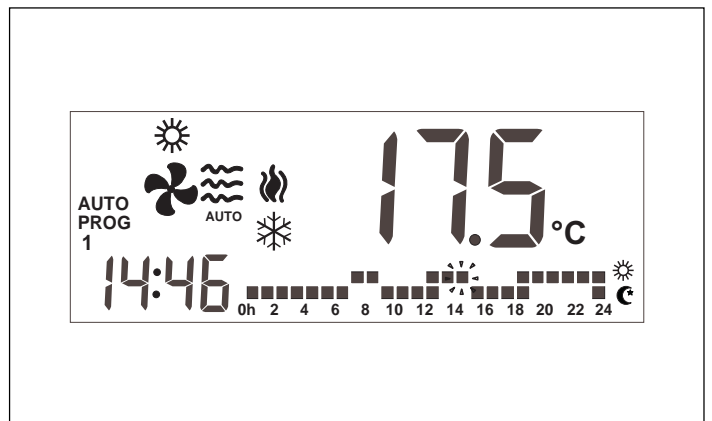

The time schedule profile defines, for each hour of the day (in 15-minute intervals), whether the set points that control the thermostat are Day (comfort) or Night (economy).

Exiting this mode recovers the temporarily changed values, set points and fan status.

If pin 2 of the micro-switch is set to OFF, this option does not appear (see Configuration of micro-switches).

## Emergency heat

This mode is a special case of *Heat Mode*, designed initially

for heat pump units also equipped with electric heaters or other auxiliary heating elements. This mode avoids operation of the compressors in extreme outdoor temperature conditions in which these devices are hardly efficient.

The display will show room temperature, the  icon (flashing if the machine is on, and static and no sides if not), the text EMERG HEAT, room occupation status (Day, Night or Unoccupied), fan status, day of the week and time.



A demand is generated when the room temperature is below the programmed set point.

### Vent only

The ventilation only mode is accessed in the OFF mode by pressing the  key to select the fan speed. The air conditioning system is now off and only the fan is operative.

The screen displays air conditioning mode OFF, room temperature, fan status, day of the week and time.



The following section details how to define fan speed.

### Ventilation

There are two possible configurations: with or without speeds (defined by pin 6 of the micro-switch. OFF indicates 3 speeds, ON indicates no speeds; see Configuration of micro-switches). If there is communication between the thermostat and the control board, the setting of 1 or 3 speeds is carried out automatically.

Configuration with no speeds allows choosing between:

- ON: Always operative. The fan appears with no wind icon.
- AUTO: Operative as needed, upon demand. The fan appears with no wind icon, but with AUTO below same.

Configuration with speeds allows choosing between:

- ON: The fan appears and the wind icons indicate the speed.
- AUTO: Operative as needed, upon demand. The fan appears with AUTO below same, and the wind icons indicate the speed.

Available speeds are as follows:

- HIGH: Maximum speed. Three wind icons.
- MED.: Medium speed. Two wind icons.
- LOW: Minimum speed. One wind icon.
- AUTO: Automatic. The system selects fan speed automatically with regard to the set point temperature. The AUTO icon flashes, appearing without wind icons. When the difference is below 1° C, speed is LOW; when between 1 and 3° C, the speed is MED; and above 3° C, the speed is HIGH.

Fan configuration can be carried out in two different ways:

- By means of the programming menu.
- Pressing the  key.

The programming menu configures the fan for each occupation status: occupied (comfort or day), stand-by (economy or night) and unoccupied. This program will be detailed further below.

Pressing the  key gives access to the *Setting* mode, that lasts 5 seconds. Pressing the key once does not change the present status; this is displayed, with the fan flashing. Pressing consecutively changes fan operation.

In the AUTO PROG mode, the change over of fan operation with the  key is temporary. When the set point is changed, the original programmed value is recovered. Upon resetting the fan, the remaining air conditioning modes change their programmed values.

The vent only mode is nothing but the setting of the fan to OFF mode. Changes made in the OFF mode do not remain when exiting this mode.

### Operating modes

There are three different thermostat operation modes available: *Normal Mode*, *Set Mode* and *Program Mode*.

Normally, the thermostat will be set to **Normal Mode**, executing the programmed temperature control algorithm and time schedule profile (if in the AUTO PROG air conditioning mode). The keys correspond to the symbols printed on them.

When, in the *Normal Mode*, the key to change the air conditioning mode, occupation status, set point temperature or fan operation is pressed, the thermostat will go to **Setting Mode**, which it will not exit until five seconds after having pressed the last setting key. This will validate all changes made in the setting process. In the setting mode the parameters that are changed flash: If the mode is changed, it flashes. If set point or occupation status are changed, the thermostat icon flashes, since the system set points are being changed. And if fan operation is changed, it flashes as well.







In *Normal Mode*, pressing the  key accesses the **Programming Mode**, where we will see the programming menu that allows changing the different thermostat parameters. In this mode, the keys change the functions associated with their symbols (operational keys: next, back, accept and delete). If no other key is pressed in 30 seconds, the thermostat goes back to the **Normal Mode**.

## Key functions

### Programming key

The word **PROG** is printed on this key.

In the Normal Mode and by pressing this key, the Programming Mode is accessed, allowing the selection of one of the following options:

-  Clock setting (day of the week, hours and minutes).
-  Fan programming.
-  Time schedule profile programming.  
A time schedule profile accepts *Comfort and Economy (Day and Night)* modes only.
-  Programming of set point temperatures for heat and cool in *Occupied, Comfort or Day Modes*.
-  Programming of set point temperatures for heat and cool in *Stand-by, Economy or Night Modes*.
-  Programming of set point temperatures for heat and cool in *Unoccupied Mode*.

Also used to define the number of days the thermostat will remain off.

### Plus and minus keys

These are  and .



Pressing one of these two keys in *Normal Mode* accesses the *Setting Mode*, displaying present temperature set point, with the  icon flashing (as long as the unit is not in OFF mode).

If pressed and held for over 1 second, or released and pressed again while still in the *Setting Mode*, said set point will be increased or decreased in steps of 0.5° C or 1° F.

If in **AUTO PROG MODE**  icon will appear flashing, indicating set point change is temporary. This change will remain valid until a change is made in the occupation of the time schedule profile. When this change in the time schedule profile is made, the programmed set points are restored. Also, if a change is made in the occupation status mode (Day/Night), the programmed set point is re-established.

In the remaining air conditioning modes these changes are made on the programmed set point values by means of the programming menu.





If the thermostat is in the **AUTO** or **AUTO PROG** mode, in the *Setting Mode* one of the heat or cool icons only will appear. If the *Setting Mode* is accessed with the  key, the heat set point is displayed; if entered with the  key, the cool set point. Once in the *Setting Mode*, the set point of the mode not displayed (from cool to heat or vice versa) can be changed by pressing the **MODE** key.

There is a total of six programmable temperature set points that correspond to the heat and cool modes of the three occupation modes (Day, Night and Unoccupied). These set points must follow a descending order:

1. Cool set point in Unoccupied mode.
2. Cool set point in Night mode.
3. Cool set point in Day mode.
4. Heat set point in Day mode.
5. Heat set point in Night mode.
6. Heat set point in Unoccupied mode.

There should be a 1° difference between two consecutive set points. If when moving one of the set points we come to less than one degree centigrade from the following set point, it will be "dragged" so as to avoid the unsuitability of the set points. When this happens, the thermostat will flash the icon of the occupation mode of this set point. Upon exiting the *Setting Mode* these flashes and icons of the dragged set points disappear.

If while in the *Normal or Setting Mode* both  and  keys are pressed simultaneously, the temperature reading goes from °C to °F, and vice versa.

In the *Programming Mode* these keys allow changing the value of the selected parameters.



### Air conditioning mode key

It has the word **MODE** printed on the key itself, and the  symbol, related to the *Programming Mode*, printed on the plastic over it.

Pressing this key in *Normal Mode* leads to the *Setting Mode*, changing the present air conditioning mode (OFF, COOL, HEAT, AUTO, AUTO PROG, EMERG HEAT). After pressing this key the air conditioning mode will be displayed and flash for 5 seconds, indicating the change, and then go back to the *Normal Mode*.

In the *Programming Mode* , this key allows selecting the previous option on the option list and move backwards through the time schedule profile when programming same.

### Occupation mode key

It has the symbol  printed on the key itself, and the  symbol, related to the *Programming Mode*, printed on the plastic next to it.

Pressing this key in *Normal Mode* leads to the *Setting Mode*, changing the present occupation or comfort mode (Day/Night) and displaying the set point temperature next to the flashing thermometer. If pressed once again while still in the *Setting Mode*, each occupation mode will be accessed one by one in a sequential and cyclic manner.

If while in the **AUTO PROG** (time schedule profile) mode the occupation mode is changed and same does not coincide with the mode programmed in the time schedule profile, the icon of the selected mode will be displayed flashing, along with the  icon, also flashing, indicating this is temporary.



When a status is changed in the time schedule profile, the occupation status will go back to the status programmed in the profile (without flashing), and the icon will disappear.



If the key is pressed and held for over 1 second, the unoccupied mode will be accessed. If no other change is made in this mode, the unoccupied status will remain indefinitely. If the key is pressed, the icon appears, the set point disappears and No. 0 is displayed in its place, indicating the number of days the unoccupied status should last. Keys and increase and decrease this number of days (with a maximum of 99). If a number greater than 0 is programmed, and while remaining in the unoccupied mode, the icon will flash to indicate this is temporary. Once the unoccupied status is concluded, the thermostat will change occupation to Day; or if the air conditioning mode is AUTO PROG, this occupation will depend upon the time schedule profile. If zero is programmed in the unoccupied mode, it will remain indefinitely.

If the air conditioning mode is AUTO PROG and there is a temporary set point setting, or a temporary fan mode (the flashes), upon changing the occupation status the programmed values are recovered and the icon stops flashing.

In the *Programming Mode* this key allows selecting the following option on the option list and to move forward through the time schedule profile when programming same.

### Fan mode key

It has the symbol printed on the key itself, and the symbol, related to the *Programming Mode*, printed on the plastic next to it.

Pressing this key accesses the *Setting Mode*, which lasts 5 seconds. In this mode the fan flashes and the programmed speed is displayed, and whether in auto or permanent mode. When pressed a first time, the present status does not change, but same is displayed only. Pressing this key repeatedly moves you through the speeds, indicated by the number of wind icons displayed, and the permanent (ON) or automatic (the word AUTO appears beneath the fan) modes. Pressing this key in the AUTO PROG air conditioning mode changes the fan configuration as described above, but when an occupation change is made the programmed values of the programming menu are re-established.

In the *Programming Mode* this allows validating the changes made.

### Outdoor temperature key

It has the symbol printed on the key itself, and the symbol, related to the *Programming Mode*, printed on the plastic next to it.

Pressing this key in *Normal Mode* displays the outdoor temperature for 5 seconds.

If pressed and held for 10 seconds, the default system configuration values are re-established:

OFF Mode.

Day Occupation.

Set points:

- Cool set point in Unoccupied mode 30° C.
- Cool set point in Night mode 27° C.
- Cool set point in Day mode 24° C.
- Heat set point in Day mode 21° C.
- Heat set point in Night mode 18° C.
- Heat set point in Unoccupied mode 15° C.

AUTO Fan, in automatic.

Origin of the temperature, internal probe.

Cancellation of the temperature probes offsets.

NORMAL temperature control.

Profiles programmed for each day of the week, P1.

In the *Programming Mode* the key allows cancelling changes made and access the previous menu level.

### Programming menu

If the key is pressed in *Normal Mode*, only the icons of the different parameters that can be programmed are displayed on screen:

- Clock setting (day of the week, hours and minutes).
- Fan program.
- Selection of time schedule profiles. A single time schedule profile accepts the *Comfort and Economy (Day and Night)* modes only. If pin 2 of the micro-switch is set to OFF, this option is not displayed.
- Set point temperature program for heat and cool in *Occupied Mode*, also called *Comfort or Day*.
- Set point temperature program for heat and cool in *Stand-by Mode*, also called *Economy or Night*.
- Set point temperature program for heat and cool in *Unoccupied Mode*.

The active or selectable option will flash. The initial option is setting the clock.

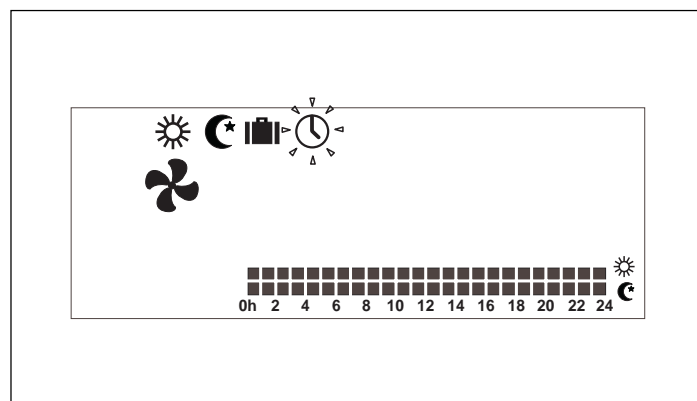

The active keys are:

- ◀▶ Allow selecting the active option (flashing). The forward order of the options will be as previously displayed: starting with the clock and finishing with the unoccupied icon.
- ✓ Selects the active option, going on to the corresponding programming menu.
- ✕ Exits the *Programming Mode*, putting the thermostat in *Normal Mode*.

If no key is pressed in the programming menu (or submenu) before 30 seconds, the programming menus are exited and the Normal Mode is re-established.

### Clock setting

Upon selecting the ⌚ option on the programming menu, this icon only (without flashing) is displayed on screen, along with the day and hour digits, with the day flashing.

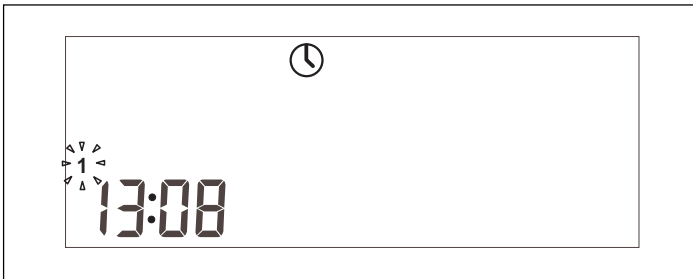

The active keys are:

- ◀▶ Allow selecting the active option (flashing). The forward order of the options is day, hours and minutes.
- - + Allow changing the selection.
- ✓ Memorizes programmed day and hour, and goes on to Programming Menu (back).
- ✕ Cancels clock setting and goes on to Programming Menu (back).

### Programming the fan

This option configures fan status in the different occupation modes, *Occupied*, *Stand-by* and *Unoccupied* (*Day*, *Night* or *Unoccupied*). Occupation and fan status are displayed.

The active keys are:

- ◀▶ Allow selecting the *Occupied*, *Stand-by* and *Unoccupied* status of the room.
- - + Allow changing fan speed and mode (ON-AUTOMATIC).
- ✓ Memorizes changes made, and goes on to the fan value of the following occupation status. If there is a temporary value set, it will be cancelled.
- ✕ Cancels the configuration menu and goes on to Programming Menu (back) without memorizing.

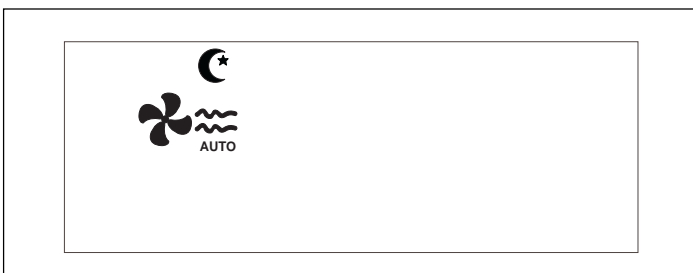

### Selection of time schedule profiles

There are three predefined profiles (P1 to P3), three additional user-programmable profiles  $P_{r1}$  to  $P_{r3}$  and 6 profiles (P7 to P12) that can be programmed through communication of the thermostat with the PC.

Upon selecting the ☀ option on the programming menu, all days of the week are displayed on screen, with day 1 of the week (Monday) flashing, the program presently memorized for this day, appearing with the temperature digits and flashing, and the corresponding profile.

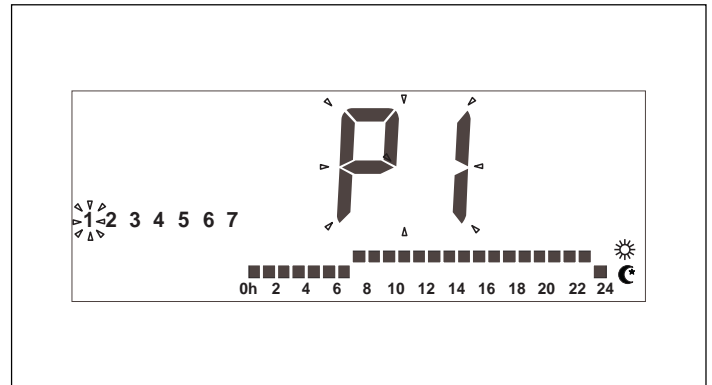

The time schedule profile displays the hours of the day 0-24, as well as the occupation status that corresponds to each hour. If at that time its occupation status is to be day (Comfort or Occupied), the upper point is displayed (at the same height as the sun icon), and if it is to be night (Economy or Stand-by) the lower point is displayed (at the same height as the night icon). If an occupation change is made in the middle of a specific hour, both points are displayed, with the present occupation point flashing.

When the user  $P_{r1}$  profile is displayed, the text  $P_{r00}$  appears in clock digits to indicate that the key with this denomination is active to program the profile.

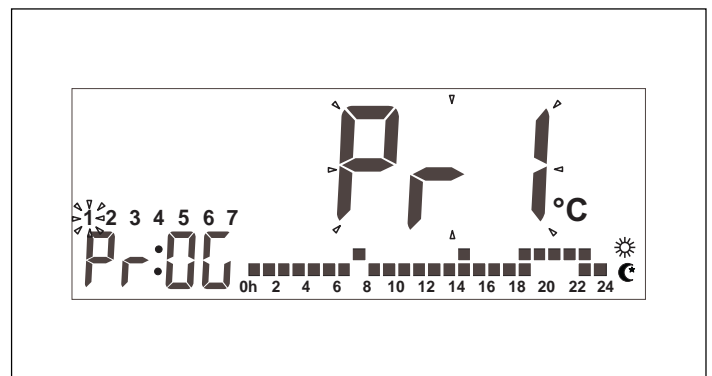

If the communication profiles are not empty, which means they are not on 24-hour stand-by, or a profile above the first six (three predefined and three user-programmable) has been selected by means of communication with the PC, profiles P7 to P12 can be selected. Should this not be the case, these profiles can neither be selected nor are displayed on screen. The active keys are:

- ◀▶ Allow selecting the day of the week.
- - + Allow changing the selected profile.
- ✓ Memorizes profiles changed up to now, and goes on to the next day.

- **X** Goes on to Programming Menu (back).
- **PROG** Active only when the **PR I** profile is displayed on screen. Allows accessing *Programming User Profile*.

The predefined profiles are 3:

- 1 The first with a 7-23-hour comfort cycle, the rest in economy (night).
- 2 The second with two comfort cycles, 7-9 and 18-23 hours, the rest in economy (night).
- 3 The third with 3 comfort cycles, 7-9, 13-15 and 18-23 hours, the rest in economy (night).

### Programming user profile

Pressing the **PROG** key while displaying the **PR I** user profile during time schedule profile selection, you have access to the programming of this profile.

Profile programming allows a 15-minute resolution in the status change program, and a minimum one-hour status duration. When a status change is inserted and you move forward within the profile, the time displayed is increased one hour automatically, instead of the usual 15 minutes. You can go back in time and the profile in 15-minute decreases. Two status changes in less than one hour are not allowed. The exception to this rule is the initial change, that can be made at any point.

Status will be overwritten as you advance in the profile. Going back, it is kept without change.

The text **PR I** is displayed on screen on the temperature digits, the initial time of the profile (00:00), the corresponding profile with the start time point flashing, and the occupation icon that corresponds to the displayed activated time (☀ or ☾).

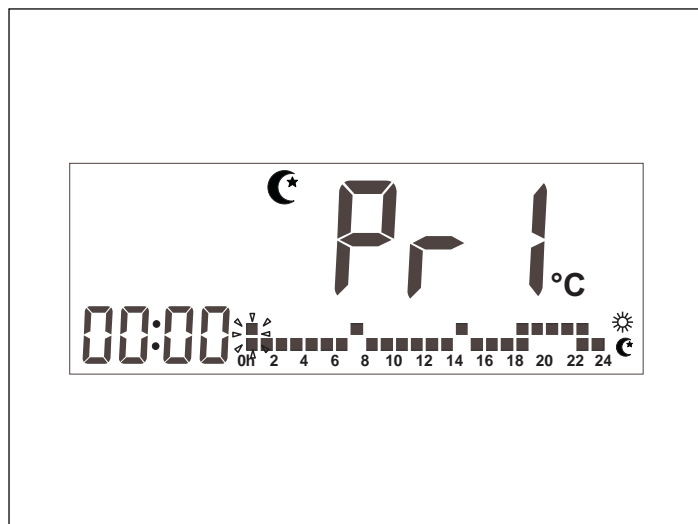

As you advance, the clock will increase, indicating the time we are programming, with the points that correspond to the present time will flash.

- **◀▶** Allow advancing and going back within the profile, increasing or decreasing the time in 15-minute intervals.
- **- +** Allow changing the profile status (Day/Night).
- **✓** Memorizes the programmed time schedule profile, and goes back to *Selection of time schedule profiles* (back) within the same day it was left.

- **X** Goes on to *Selection of time schedule profiles* (back) without saving.
- **PROG** Pressing and holding allows recovering the factory programmed default values, and save these values.

### Programming comfort temperature set points (Occupation or Day)

Upon selecting the ☀ option on the programming menu, this icon is displayed without flashing, whereas the 🔥, ❄, and 🌙 icons are flashing. The temperature set point of this mode is also displayed.



There is a total of six programmable temperature set points that correspond to the heat and cool modes of the three occupation modes (Day, Night and Unoccupied). These set points must follow a descending order:

- a. Cool set point in Unoccupied mode.
- b. Cool set point in Night mode.
- c. Cool set point in Day mode.
- d. Heat set point in Day mode.
- e. Heat set point in Night mode.
- f. Heat set point in Unoccupied mode.

There should be a 1° C difference between two consecutive set points. If when moving one of the set points we come to less than one degree centigrade from the following set point, it will be "dragged" so as to avoid the unsuitability of the set points. When this happens, the thermostat will flash the icon of the occupation mode of this set point being dragged.

The active keys are:

- **◀▶** Allow choosing between the heat and cool set points, in each displaying the corresponding flashing icons (🔥 or ❄).
- **- +** Allow changing the set point selected.
- **✓** Memorizes the two Comfort set points and shows the present set point that is not displayed at this moment.
- **X** Goes on to Programming Menu (back) without saving.
- **PROG** Pressing and holding allows recovering the factory programmed Comfort default values.

### Programming economy temperature set points (Stand-by or Night)

Upon selecting the ☾ option on the programming menu, this

icon is displayed without flashing, whereas the 🔥, ❄️, and 🌙 icons are flashing. The temperature set point of this mode is also displayed.



If when moving one of the set points we come to less than one degree from the following set point, it will be "dragged" so as to avoid the unsuitability of the set points. When this happens, the thermostat will flash the icon of the occupation mode of this set point being dragged.

The active keys are:

- ◀▶ Allow choosing between the heat and cool set points, in each displaying the corresponding flashing icons (🔥 or ❄️).
- (-) (+) Allow changing the set point selected.
- ✓ Memorizes the two Economy set points and shows the present set point that is not displayed at this moment. In the case of dragged set points, all are saved.
- ✕ Goes on to Programming Menu (back) without saving.
- (PROG) Pressing and holding allows recovering the factory programmed Economy default values.

### Programming unoccupied temperature set points

Upon selecting the 📅 option on the programming menu, this icon is displayed without flashing, whereas the 🔥, ❄️, and 🌙 icons are flashing. The temperature set point of this mode is also displayed.



If when moving one of the set points we come to less than one degree from the following set point, it will be "dragged" so as to avoid the unsuitability of the set points. When this happens, the thermostat will flash the icon of the occupation mode of this set point being dragged.

The active keys are:

- ◀▶ Allow choosing between the heat and cool set points, in each displaying the corresponding flashing icons (🔥 or ❄️).
- (-) (+) Allow changing the set point selected.
- ✓ Memorizes the two Unoccupied set points and shows the present set point that is not displayed at this moment. In the case of dragged set points, all are saved.
- ✕ Goes on to Programming Menu (back) without saving.
- (PROG) Pressing and holding allows recovering the factory programmed Unoccupied default values.

### Thermostat in unoccupied mode

In any air conditioning mode, excluding the OFF mode, pressing the 🌙 key for 1 second accesses the *Setting Mode* and thermostat occupation is changed to Unoccupied.

If no other action is carried out, the unoccupied mode remains indefinitely.

If the (PROG) key is pressed while in the *Setting Mode*, the 🕒 icon is displayed, the set point disappears and the No. 0 appears in its place, indicating the number of days the unoccupied status should last. Keys (-) and (+) increase and decrease this number of unoccupied days. If 0 is left this status will remain indefinitely. If a number greater than 0 is programmed, the 🕒 icon will flash while this unoccupied status remains, to indicate this is temporary. Once the unoccupied status is concluded, and the number of programmed days is over, the thermostat will change occupation to Day; but if the air conditioning mode is AUTO PROG, this occupation will depend upon the time schedule profile.

To exit this Unoccupied mode, just press the 🌙 key.

### Menu of supervising program

Entering the programming menu and pressing keys ◀▶ simultaneously, the first supervising menu will be displayed; and pressing the (PROG) key the different submenus will appear on screen.

Submenus:

- Programming calibrations of temperature readings.
- Programming origin of temperature readings.
- Programming operating mode of the temperature control.
- Activation and deactivation of communication error readout.
- Selection of outdoor probe, analogue or digital.

### Programming calibrations of temperature readings

The first supervising submenu, P1, is the programming calibrations of temperature readings of the different origins of the temperature value (different temperature probes).

P1 is displayed in clock digits, indicating Program 1, and S1, S2, S3 or S4, indicating the probe selected.

If the digital probe is selected, S5, S6, S7 and S8 will also appear, depending upon the number of probes installed.

The calibration appears in temperature digits. The maximum permissible is  $\pm 3^{\circ}\text{C}$ .



S1: internal probe.

S2: remote probe.

S3: remote probe in ducts.

S4: Economiser probe.

The active keys are:

- ◀▶ Allow choosing the origin of temperature S1, S2, S3, S4, S5, S6, S7 and S8.
-   Allow changing the calibration up to a maximum of + or minus  $3^{\circ}\text{C}$ .
- ✓ Memorizes all changed calibrations, and goes back to the user programming menu.
- ✗ Cancels changes made, and goes back to user programming menu.



Physically, S2 and S3 are one single probe. Therefore, the value of S2 and S3 will be one single value. This is also applicable to probes S5, S6, S7 and S8.

### Programming origin of temperature readings

Submenu P2, programming origin of temperature readings.

P2 is displayed in clock digits, indicating Program 2.

S1, S2, S3, S4, S5, S6, S7 and S8 is displayed in temperature digits, indicating:

S-1: internal probe.

S-2: remote probe.

S-3: remote probe in ducts.

S-4: economiser probe.

S5, S6, S7 and S8: digital remote probe.

On this menu you can select the origin of the temperature. When the value give is incorrect, an error 91 - error of NTC probe - is generated, and another origin is selected, as follows:

If S1 is selected and gives an error: S3 is selected and S4 is given as an error.

If S2 is selected and gives an error: S4 is selected.



If S3 is selected and gives an error: S4 is selected.

If S4 is selected and gives an error: S3 is selected.

If S5 and S6 and S7 and S8 are selected: goes on to S4 is no digital remote probe is in operation.

On the other hand, when probes S3 or S4 are used, and in Day mode, 1-minute fan operation is activated every 15 minutes (unless in the OFF mode). This is carried out to keep the duct temperature equal to the room temperature.

The active keys are:

-   Allow changing the selected origin, S-1 to S-8.
- ✓ Memorizes selected value, and goes back to the user programming menu.
- ✗ Cancels changes made, and goes back to user programming menu.



### Programming operating mode of the temperature control



Submenu P3, programming operating mode of temperature control.

P3 is displayed in clock digits, indicating Program 3.

Tur, nor or Eco is displayed in temperature digits, indicating:

- tur: quick temperature control (TURBO). Reaching set point temperature is expected in 5 minutes (ideally).
- nor: NORMAL temperature control. Reaching set point temperature is expected in 10 minutes (ideally).
- nor: ECONOMY temperature control. Reaching set point temperature is expected in 20 minutes (ideally).

The active keys are:

-   Allow changing the selected mode.
- ✓ Memorizes selected value, and goes back to the user programming menu.
- ✗ Cancels changes made, and goes back to user programming menu.

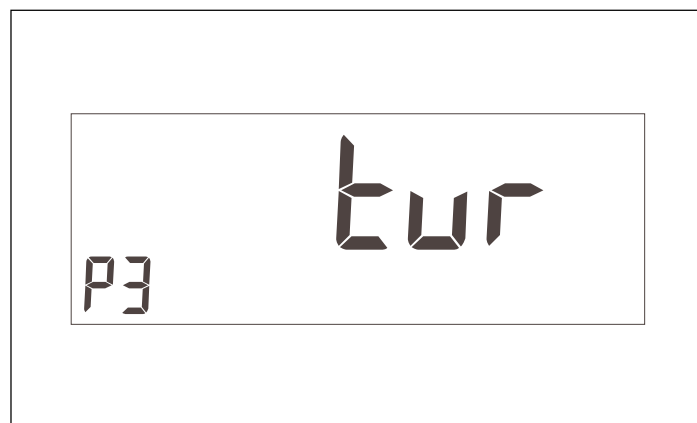

### Activation and deactivation of communication error readout

Submenu P4.





P4 is displayed in clock digits, indicating Program 4.

C-Y or C-n is displayed in temperature digits, indicating:

- C-Y: the thermostat is in communication with the machine. This implies that if there were no communication, an error would be indicate on screen as Er 93.

- C-n: the thermostat is not in communication with the machine. The communication error Er 93 would not be displayed on screen.

The active keys are:

-   Allow changing the selected mode.
-  Memorizes selected value, and goes back to the user programming menu.
-  Cancels changes made, and goes back to user programming menu.

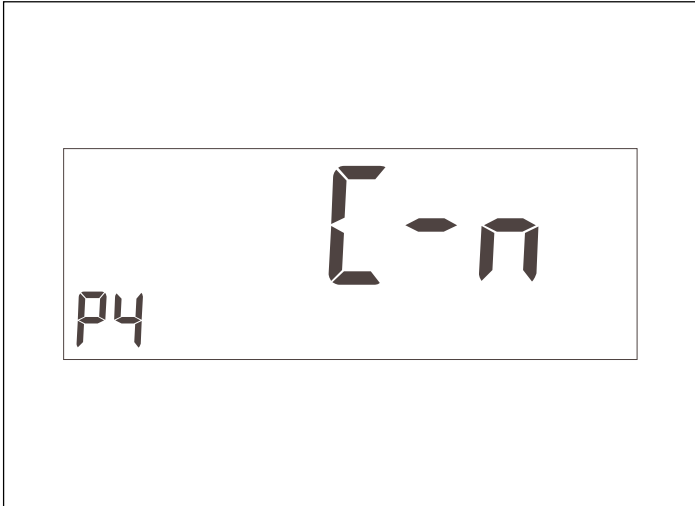

### Selection of outdoor probe type





Submenu P5

The clock digits display P5, indicating program 5.

The temperature digits display EA and Ed, which mean:

- EA. The thermostat displays the value of the analogue outdoor probe installed on the YKlon board or on the economiser board.
- Ed. The thermostat displays the value of the digital outdoor probe connected to the thermostat communications terminal. Both microswitches of the digital probe must be selected in ON position. In this case, the maximum number of digital remote probes will be three.

The active keys are:

-   Allow changing the selected mode.
-  Memorizes selected value, and goes back to the user programming menu.
-  Cancels changes made, and goes back to user programming menu.



### Micro-switches for configuration of the thermostat



The SW1 micro-switches for configuration are inside the thermostat, in the back of the front panel.

To open the thermostat correctly, please read the installation instructions in this manual: Fastening the thermostat.

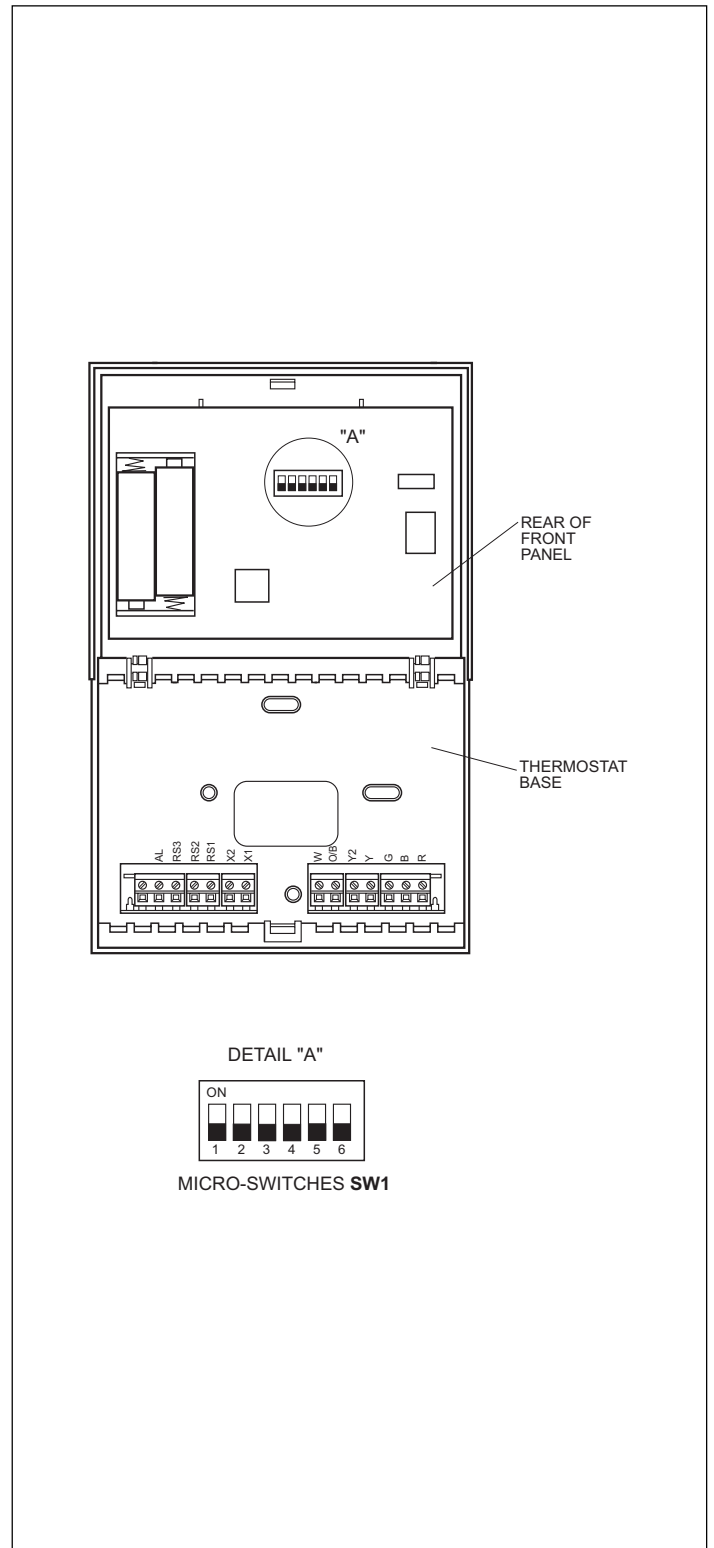
For standard thermostat operation, these pins are factory-set to OFF. Nevertheless, these settings can be change in accordance to user needs. The functions of each one are as follows.



Micro-switch SW1 allow the configuration of the following parameters:

- Pin 1: Lock keyboard. In OFF the keyboard is not locked. In ON the keyboard is locked and the locked keyboard icon (key) is displayed. The keys that remain active are: ,  and  (Consult outdoor temperature).
- Pin 2: AUTO PROG mode activated. Defines whether the automatic air condition mode with time schedule programming (time schedule profiles) can be activated. OFF indicates the AUTO PROG mode is deactivated, and ON indicates the AUTO PROG mode can be selected.
- Pin 3: O/B signal: Set to OFF, heat is generated when the O/B (24 VAC) signal is active, and cool when inactive. Set to ON, cool is generated when the O/B (24 VAC) signal is active, and heat when inactive.
- Pin 4: 2 minutes/4 minutes. Defines the time between the end of one phase and when it can be active again. OFF indicates 2 minutes, and ON, 4 minutes.
- Pin 5: Multi-stage. Defines single-stage (one stage can be activated only) or multi-stage (more than one can be activated). OFF indicates single-stage and ON, multi-stage. In heat, if stage W exists, in single-stage Y1 and W are activated.
- Pin 6: Single-speed fan. Defines whether the fan can operate at one or three speeds. OFF indicates 3 speeds and ON, 1 speed. In single-speed, the wind icons are not displayed.

By default, all micro-switches are set to OFF.

## Default parameters

OFF Mode.

Day occupation.

Set points:

- Cool set point in Unoccupied mode 30° C.
- Cool set point in Night mode 27° C.
- Cool set point in Day mode 24° C.
- Heat set point in Day mode 21° C.
- Heat set point in Night mode 18° C.
- Heat set point in Unoccupied mode 15° C.

AUTO Fan, in automatic.

Origin of the temperature, internal probe.

Cancellation of the temperature probes offsets.

NORMAL temperature control.

Profiles programmed for each day of the week, P1.

## Alarms

The alarm codes are displayed at the bottom left of the screen, overlapping hour and minutes.

The alarm codes are as follows:

- 0-90, machine error codes.
- 91, temperature origin selected is invalid.
- 92, indoor temperature sensor not calibrated.
- 93, communication alarm.
- 94, Failure with terminal "AL" connected.
- 95-99, Digital probe not detected.

When an alarm is generated, the wrench icon is displayed. If the error is machine or communication, this icon flashes; if not it remains static.

Filters. If the dirty filters icon is displayed flashing, the filters need to be changed.

Dead battery. The dead battery icon indicates the batteries are dead, and these should be changed. System configuration is not lost when changing the batteries. Only day and time are lost.

## Table of failures

Code	Designation
11 / 21 / 31	Compressor discharge temperature surpassed or short circuited probe
12 / 22 / 32	High Pressure switch, outdoor fan overload or compressor motor protection module
13 / 23 / 33	Low Pressure switch
14	Indoor fan thermal switch
15 / 25 / 35	Repeated start-ups in cool, or suction temperature < -25°C
16	Liquid temperature < -30°C
41	Gas 1 or electrical heater 1
42	Gas 2 or electrical heater 2
43	Electrical heater 3
44	Electrical heater 4
45	Economizer or hot water coil
46	Smoke detector, fire thermostat or air discharge temperature probe (rooftop only) >80°C
91	Selected probe not valid or short circuited probe
92	Thermostat internal probe not calibrate
93	No communication between the thermostat and the main PCB (Yklon)
94	Failure with terminal "AL" connected
95	Digital probe S5 not detected
96	Digital probe S6 not detected
97	Digital probe S7 not detected
98	Digital probe S8 not detected
99	Outdoor digital probe not detected

## Temperature control

The purpose of this thermostat is to keep the room at the temperature established by the set points. When operating in AUTO or AUTO PROG, the heat and cool set points are used. However, when operating in HEAT the heat set points are used only, and when operating in COOL the cool set points are used only. When the temperature between the real temperature and the set point is more than 0.2° C, the first stage Y1 is activated. If after a while (depending upon the temperature control operating mode TURBO, NORMAL, ECONOMY) the temperature has not recovered, the second stage Y2 is acti-

vated. If the set point is still not reached, and after a certain period of time, the third stage W is activated (in HEAT only). When the real temperature is close to the set point in 0.1° C, W is deactivated and Y2 is deactivated at the set point temperature, and when the set point temperature is surpassed by 0.1° C, Y1 is deactivated.

Operating with temperature probe S-4 is a special case. The temperature is received by communication with the machine. In this case, the temperature is in steps of 0.5° C and, therefore, control is different. When the difference between the room temperature and the set point is greater than or equal to the set point temperature, the first stage is activated. The same as in the previous case, if after a while the set point is not reached, stages Y2 and W are activated successively (in HEAT). Once the temperature reaches the set point, the stages go off.

## Communication

The DPC-1 thermostat operates by communication only. By communication it is possible to monitor the status of the thermostat, while being able to program same. In other words, all parameters that are changeable by means of keys can be modified by means of communication, except for the temporary parameters and the number of days in unoccupied mode. There are also 6 time schedule profiles that can be programmed by means of communication only, and these go from 7 to 12. If not programmed or used, these profiles are not displayed on the profile programming menu when accessed through the keyboard.

## Installation instructions

It is recommended that the installation be carried out by a qualified contractor.

### Location

To assure adequate operation, this thermostat should be installed on an indoor wall, in a frequently occupied area of the building. Furthermore, it should be at least 46 cms. from any outdoor wall, and at approximately 1.5 m. above floor level, in an area with free air flow and at an average temperature. The following locations should be avoided:

- Behind doors or in corners with no free air flow.
- Spots where direct sunlight or heat generated by other appliances may alter the control operation.
- On an outdoor wall.
- Next to or aligned with air conditioning discharge grids, stairwells or doors leading outdoors.
- Spots where its operation can be affected by gas or water pipes, or hot air chimneys in adjacent areas or any other area without environmental control behind the thermostat.
- Spots where its operation can be affected by the supply air of any adjacent unit.
- Near sources of electric interference, such as arch relay contacts.

### Basic elements

This thermostat comprises three basic parts:

- Hinged front cover.
- Front panel. The operating and control buttons are found in

this element. It is fastened to the base by means of a plastic tab.

- Thermostat base. This is the box that allows fastening the thermostat to the wall, and contains the printed circuit and the electric connecting strips.

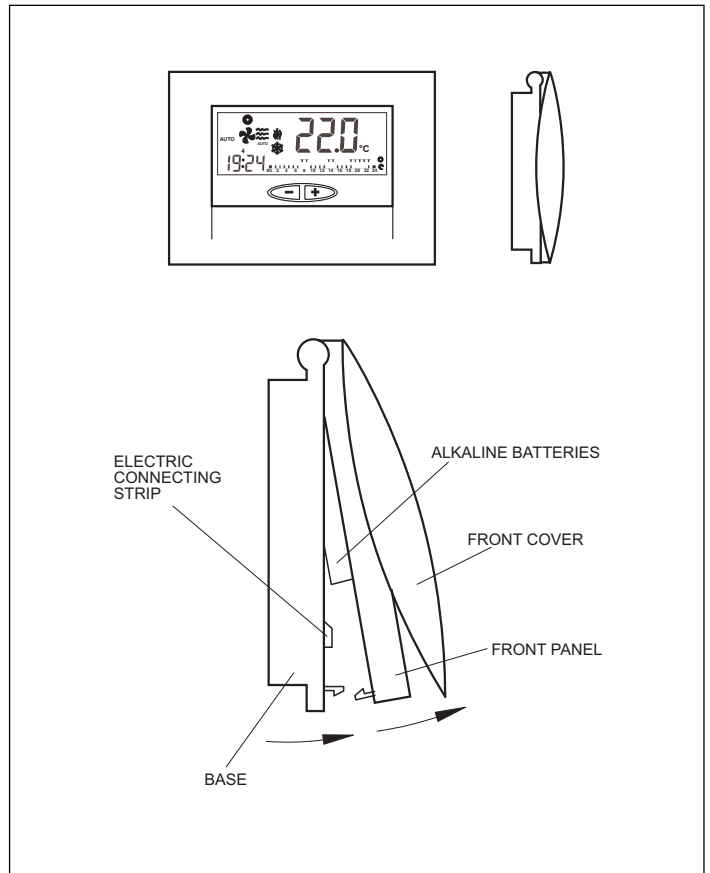

### Fastening the thermostat to the wall

To fasten the thermostat to the wall, first open the front panel and uncover the base of the thermostat. Proceed as shown in the following illustration:

- 1- Press the plastic tab at the base of the thermostat, as indicated by arrow A.
- 2- While pressing A, raise the front panel as indicated by arrow B.

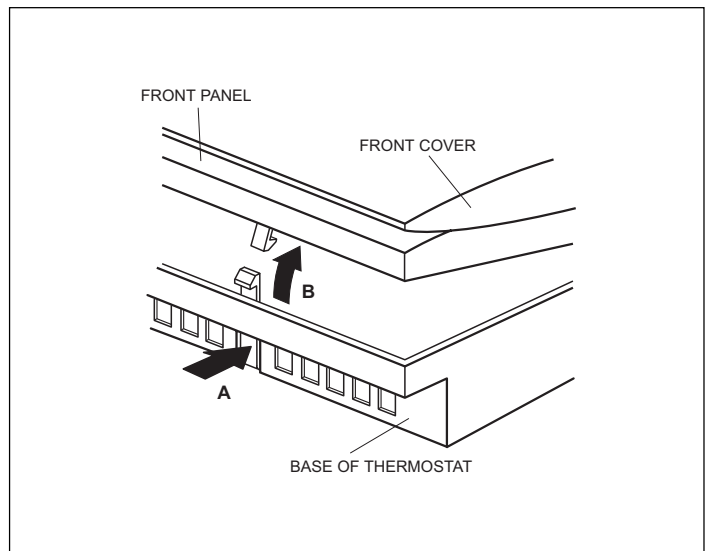



The fastening holes found at the base coincide with the standard electric boxes on the market.

In the case the connecting cable does not come from the electric box, the thermostat must be fastened to the wall with the wedges and screws supplied.

Keep in mind that the rectangular hole in the centre of the base is to house the electric connecting cable.

### Standard electric connections, thermostat DPC-1 (for thermostat with communication)

Once the base is fastened to the wall, wire the thermostat as shown in the following illustration:

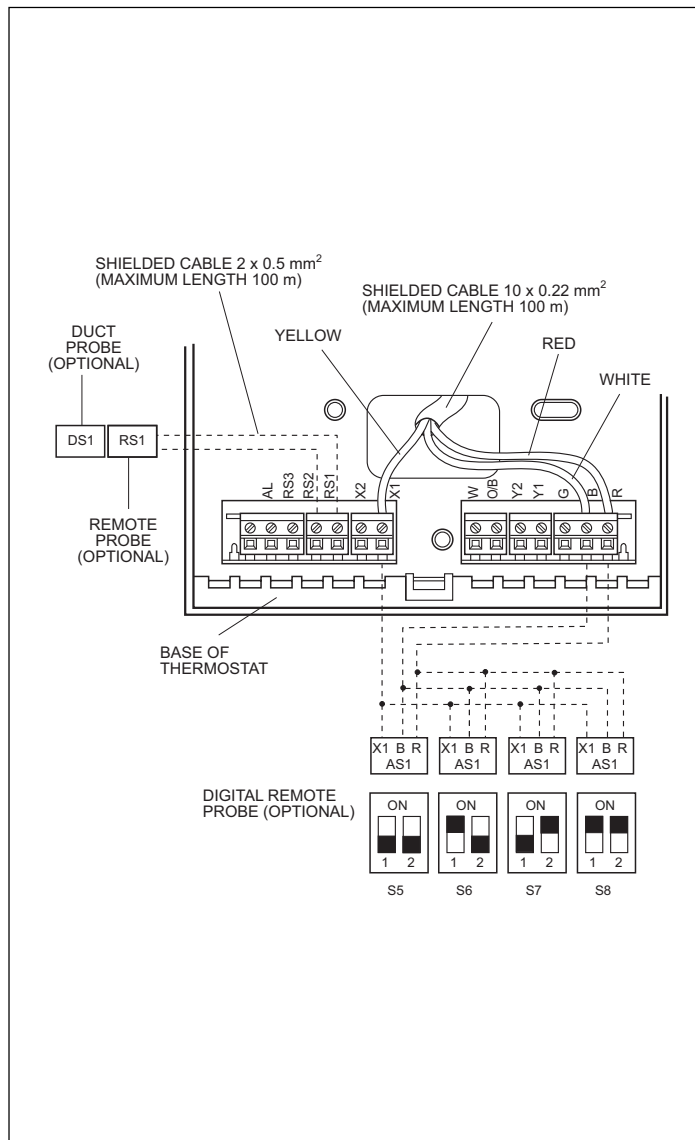

#### Precaution



A 10 x 0.22 mm<sup>2</sup> shielded cable with a maximum length of 100 m. should be used between the thermostat and the control board. The connections to be made are **R, B and X1**. (The remaining 7 cables are necessary if a thermostat is to be used with relays with connections G, Y1, Y2, O/B, W.)

To connect the remote sensor connection, a shielded 2 x 0.5 mm<sup>2</sup> cable with a maximum length of 100 m. should be used between the thermostat and the sensor. The connections to be made are RS1 and RS2.

For digital remote probe connection, use shielded 3 x 0.5 mm<sup>2</sup> cable with a maximum length of 100 m. between the thermostat and the last probe. Connections to be made are: **R, B and X1**.

For correct operation of the thermostat, it is indispensable to have made electric properly, and have inserted the two AAA 1.5 V alkaline batteries at the rear of the front panel, as shown below:

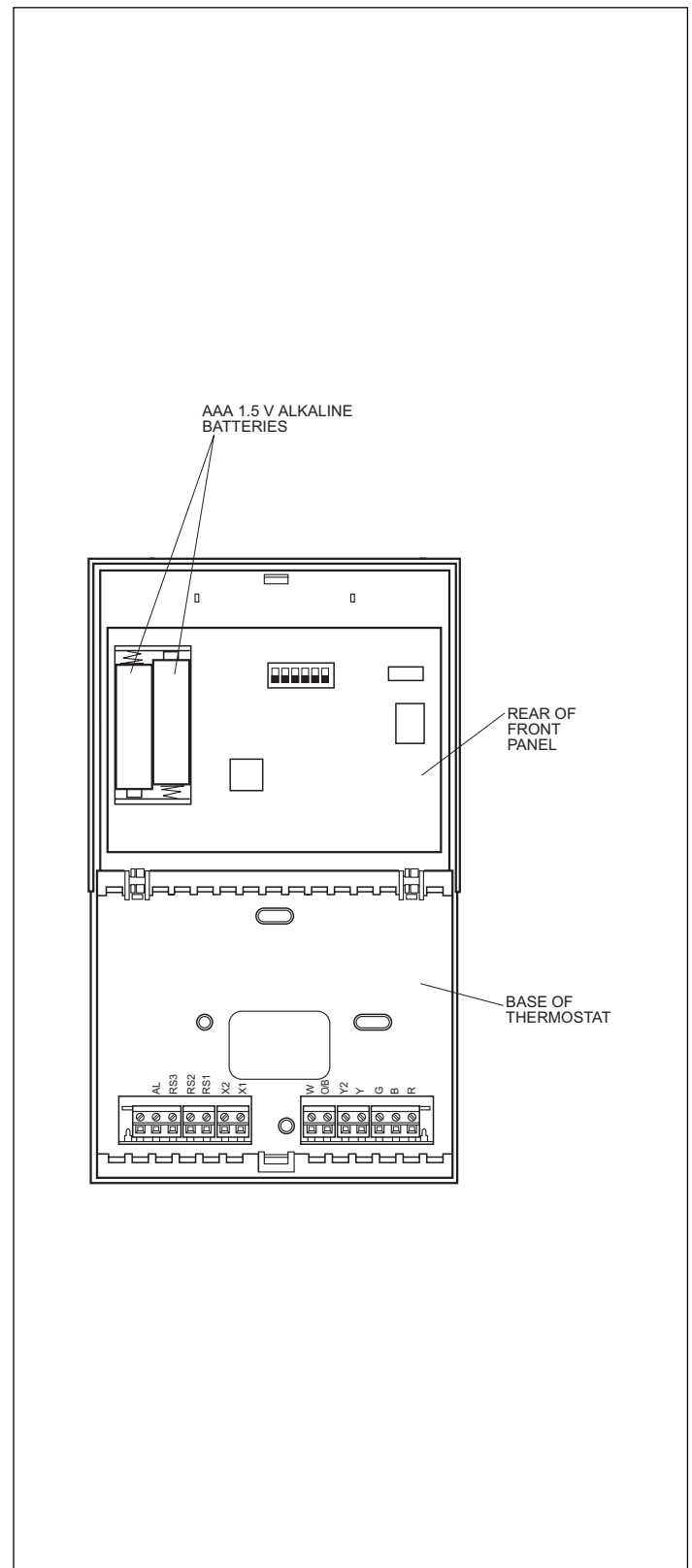

## Temperature table

The following table indicates the ratio between the temperature, heater and voltage. Ambient probe 15 K Ohm: Thermo-

stats DPC-1 and DPC-1R, ambient remote probe (RS-1), ducts remote probe (DS-1) and average probe (AS-1).

Temperature °C	NTC value	Current
-5	57 382	0.445
-4	54 657	0.464
-3	52 077	0.483
-2	49 633	0.503
-1	47 317	0.523
0	45 122	0.544
1	43 041	0.566
2	41 068	0.587
3	39 196	0.610
4	37 419	0.633
5	35 733	0.656
6	34 132	0.680
7	32 612	0.704
8	31 167	0.729
9	29 795	0.754
10	28 490	0.779
11	27 250	0.805
12	26 070	0.832
13	24 947	0.858
14	23 880	0.885
15	22 863	0.913
16	21 895	0.941
17	20 974	0.969
18	20 096	0.997
19	19 259	1.025
20	18 462	1.054
21	17 702	1.083
22	16 978	1.112
23	16 287	1.141
24	15 627	1.171
25	14 998	1.200
26	14 398	1.230
27	13 824	1.259
28	13 277	1.289
29	12 754	1.318
30	12 254	1.348
31	11 777	1.378
32	11 321	1.407
33	10 884	1.436
34	10 467	1.466
35	10 068	1.495
36	9 686	1.524
37	9 321	1.553
38	8 971	1.581
39	8 636	1.610
40	8 316	1.638
41	8 009	1.666
42	7 715	1.694
43	7 433	1.721
44	7 163	1.748
45	6 904	1.775
46	6 656	1.801
47	6 418	1.827
48	6 189	1.853
49	5 970	1.878
50	5 760	1.904

All data subject to change without notice.



